

EM Aware Monitor Installation, Operation and Maintenance



Made in the
United States of America



Figure 1. SCS 770066 EM Aware Monitor with standard antenna



Figure 2. SCS 770066 EM Aware Monitor with ionizer antenna

Description

The SCS 770066 EM Aware Monitor monitors three key parameters that keep you aware of critical symptoms of ESD problems: ESD events, change in static voltage field, and ionizer performance*. The thresholds for these parameters are fully adjustable. The monitor is constructed of an aluminum enclosure, LCD display, control joystick, remote antenna, relay terminal and Ethernet connectivity.

ESD events generate electromagnetic radiation. The stronger the ESD event, the stronger the electromagnetic radiation. The EM Aware Monitor is a miniature radio receiver tuned to detect and measure the unique waveform generated by an ESD event.

The EM Aware Monitor meets the Continuous Monitor requirements of ANSI/ESD S20.20 in accordance with ESD TR1.0-01 and ANSI/ESD STM3.1. It meets the recommendations of ESD Handbook ESD TR20.20 which includes “if the products that are being produced are of such value that knowledge of a continuous, reliable ground is needed, and then continuous monitoring should be considered or even required”.

**The ionizer must have a balance (offset voltage) of ± 40 V or better.*

The EM Aware Monitor and its accessories are available as the following item numbers:

Item	Description
770066	EM Aware Monitor
CTC111-6FT	Antenna, Room Temperature, 6 ft.
CTC118-6FT	Antenna, High Temperature, 6 ft.
770145	Plastic Cap for CTC111 Antenna
770064	Power Adapter, 100-240 VAC Input, 7.5 VDC 1.5 A Output, All Plugs
770121	SMP Web App



Static Management Program

The SCS 770066 EM Aware Monitor is compatible with SCS Static Management Program (SMP). SMP continuously monitors your ESD process control system throughout all stages of manufacturing. SMP captures data from SCS workstation, equipment and ESD event continuous monitors and provides a real-time picture of critical manufacturing processes. All activity is stored into a database for on-going quality control purposes. SMP allows you to pinpoint areas of concern and prevent ESD events. Quantifiable data allows you to see trends, become more proactive and prove the efficiency of your ESD process control system.

SMP is sold separately. [Click here](#) to learn more.

Packaging

- 1 EM Aware Monitor
- 1 [CTC111-6FT](#) Antenna with 6 ft. Cable
- 1 Interchangeable Ionizer Antenna
- 1 Monitor Ground Cord (Green and Yellow)
- 2 Ring Magnets
- 1 Ring Terminal
- 2 Screw, Flat Head, 4-40 x 3/8"
- 1 Screw, Pan-Head, 6-32 x 1/4"
- 1 Star Washer
- 1 Power Adapter, 7.5 VDC, with interchangeable plugs (North America, UK/Asia, Europe, China)

Features and Components

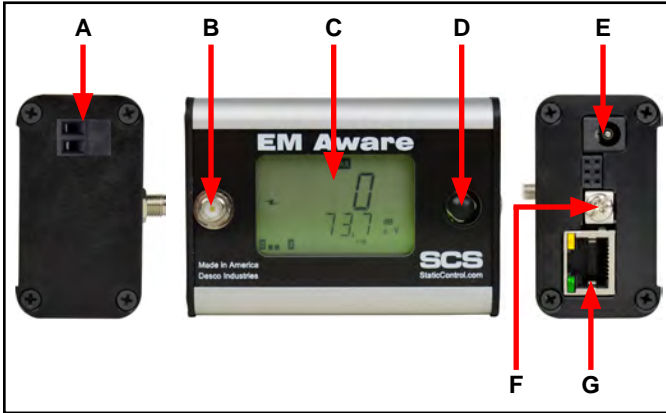

Figure 3. EM Aware Monitor features and components

- A. Relay Terminal:** Integrates with electronic tools, lights, buzzers, etc.
- B. Antenna Input:** Connect to the antenna using the included cable.
- C. LCD Display:** Displays measurements and settings.
- D. Joystick:** Toggles displayed measurements and monitor settings.
- E. Power Jack:** Connect the included 7.5 VDC power adapter here.
- F. Ground Terminal:** Common ground point for the monitor.
- G. Ethernet Jack:** Provides network communication between the EM Aware Monitor and [Static Management Program \(SMP\)](#).

Installation

Hardware Setup

1. Remove the monitor and antenna from the carton.
2. Determine the installation location of the remote antenna. For optimal performance, position the remote antenna as close as practically possible to the anticipated source of ESD activity. Use the mounting tabs on the remote antenna to properly secure it to the desired location.
3. If the remote antenna is to be used to monitor an ionizer, replace the standard metal antenna on top of of the remote's enclosure with the included ionizer antenna. The antennas may be screwed on and off. The ionizer antenna utilizes its increased surface area to capture more ions for measurement.



Figure 4. Replacing the standard antenna with the ionizer antenna

4. Connect the antenna's cable to the EM Aware Monitor without bending it.
5. Determine the mounting location of the monitor. Its display should be visible to the operator. Use the two 4-40 threaded holes at the back of its enclosure and the included ring magnets and 4-40 threaded screws if desired.

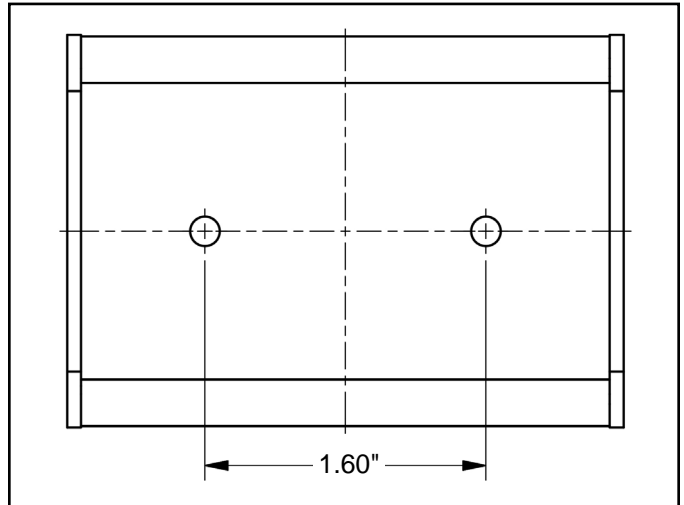

Figure 5. Mounting hole locations on the back of the EM Aware Monitor

6. Secure one end of the included ground cord to the ground terminal located on the right-side of the monitor. Attach the other end of the cord to a ground point. The face plate screw of a grounded AC wall outlet may provide a convenient connection point.
7. Connect an Ethernet cable to the Ethernet jack located on the right-side of the monitor. Verify that the cable is properly connected to a network.

8. Connect the power adapter to the power jack located on the right-side of the monitor. Route the wire from the power adapter to a nearby AC outlet and plug it into the outlet. Make sure the voltage and frequency match those listed on the power supply. The monitor is now powered.

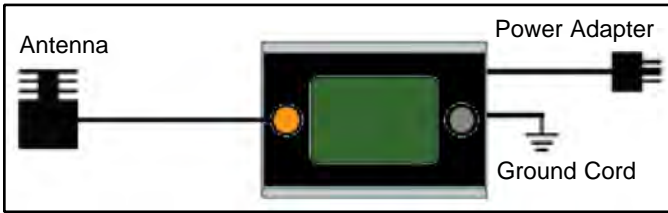

Figure 6. Stand-alone setup for the EM Aware Monitor

Relay Terminal

The EM Aware Monitor features one optical relay terminal that can be integrated with electronic tools, lights, buzzers, etc. The relay opens when the monitor enters an alarm condition, and it remains closed otherwise. Alarm conditions include ESD events and exceeded static voltage and ionizer balance thresholds.

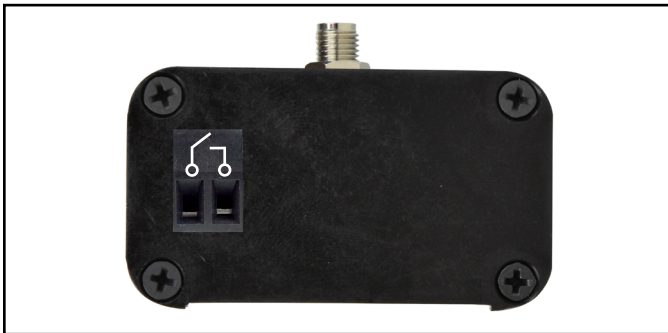

Figure 7. Relay terminal pin-out

Parameter	Rating
Peak Blocking Voltage	400 V _p
Load Current	140 mA _{rms} / mA _{DC}
On-Resistance (max)	22 ohms

SMP Network Setup

The following procedure outlines how to connect the EM Aware Monitor to SMP via a local area network (LAN). SMP must be installed on a PC prior to using this procedure. The diagram shown below illustrates a common SMP system setup that utilizes the server software, client software, WS Aware Monitor, EM Aware Monitor, and Ground Master Monitor.

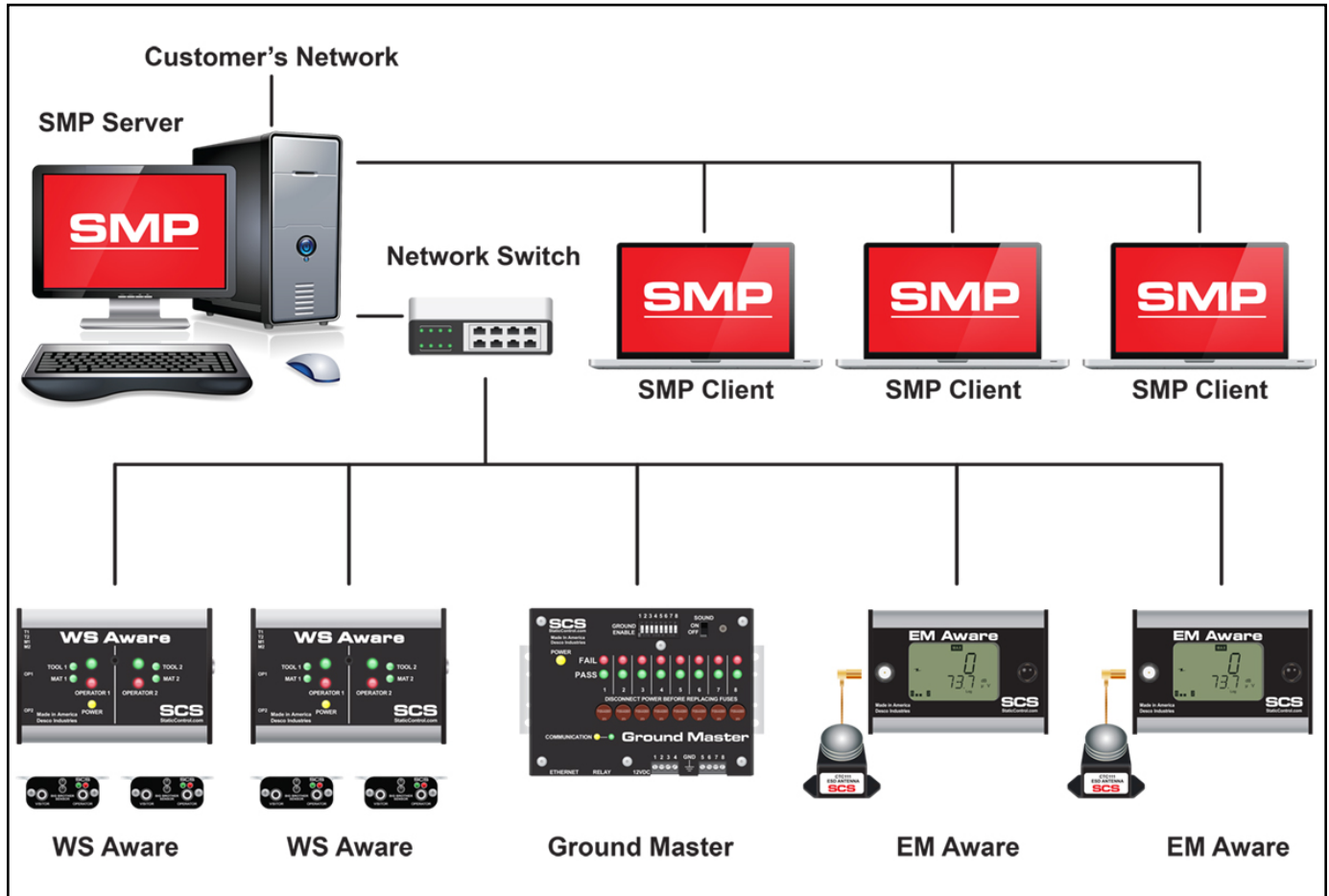
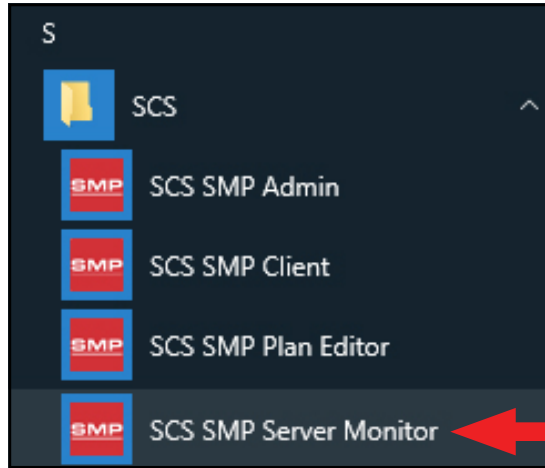

Figure 8. SMP system setup

DYNAMIC IP PROCEDURE

1. Verify that the Ethernet cable is securely connected to your network and EM Aware Monitor. The LEDs on the Ethernet port will illuminate when a connection to the network is established.
2. Open SCS SMP Server Monitor.



3. The SMP Server icon will appear in the Windows taskbar.

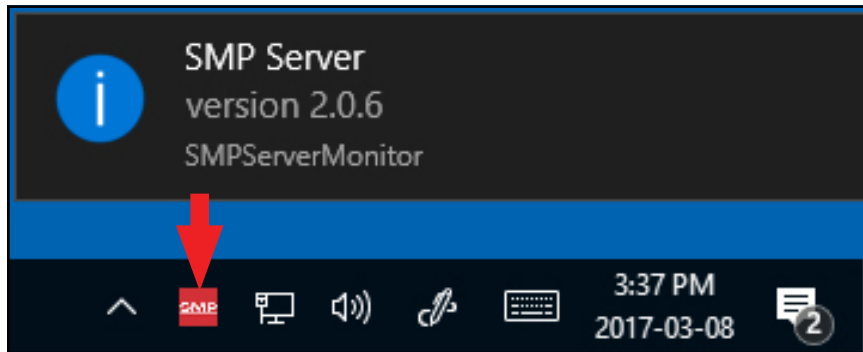

4. Click the SMP Server icon located on the Windows taskbar. The SMP Server menu will appear. Click the Start button to start SMP Server.

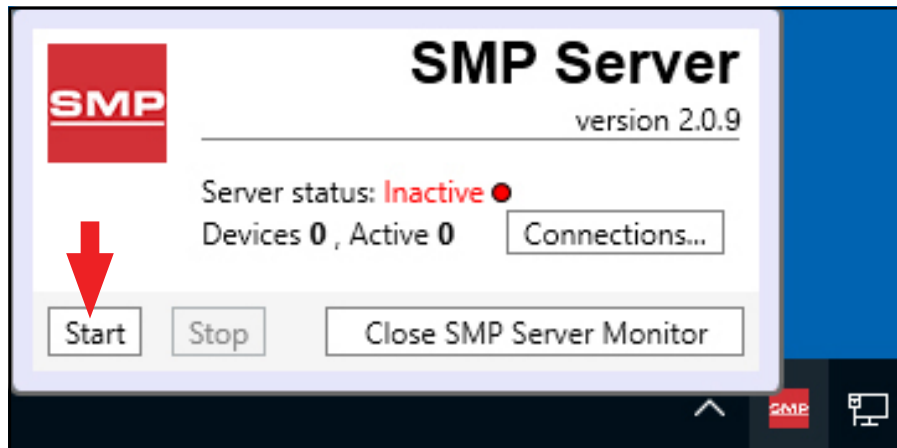

5. A message will appear and display "Starting SMP Server..." Click the SMP Server icon located in the Windows taskbar.

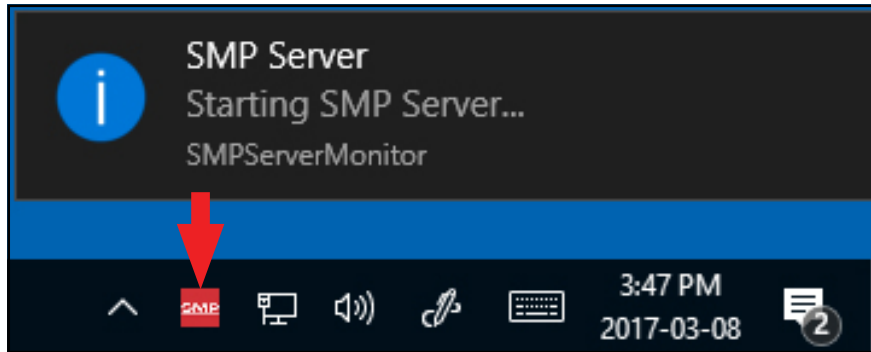

6. SMP Server will now indicate Active server status.

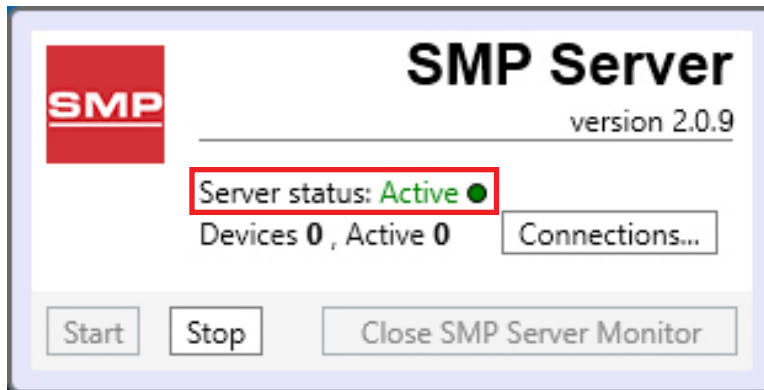

7. SMP Server will search and find the EM Aware Monitor on the network. The Device and Active counts will increase to 1.

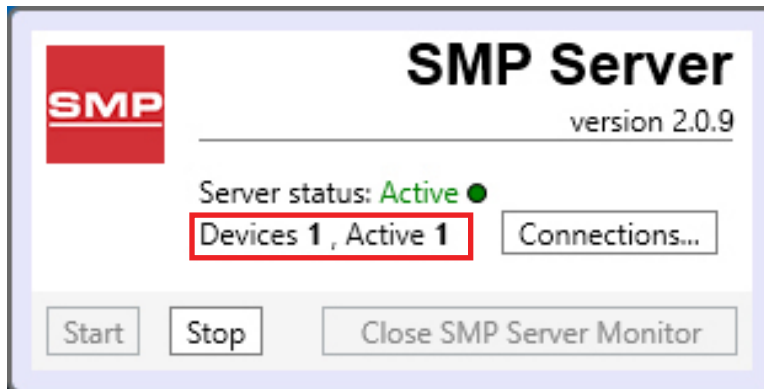

8. Open SCS SMP Admin.

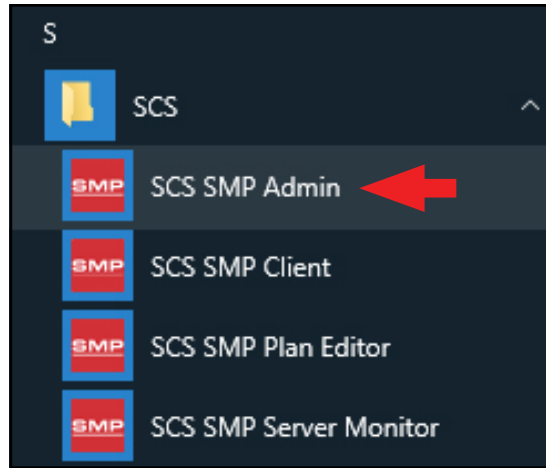

9. The window for SMP Server Admin will appear. "1 unassigned" is representative of the EM Aware Monitor that was just found by SMP Server. Click the Add New Building button.

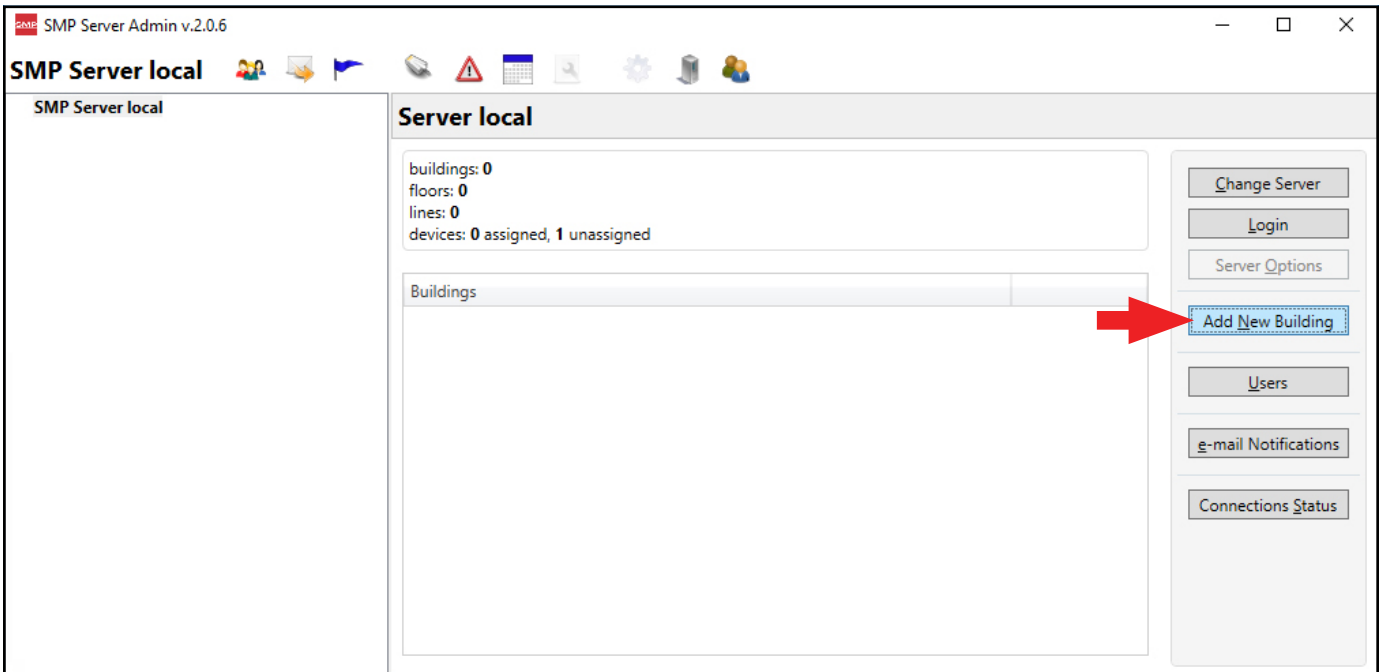

10. Enter a building name, and then click the OK button.

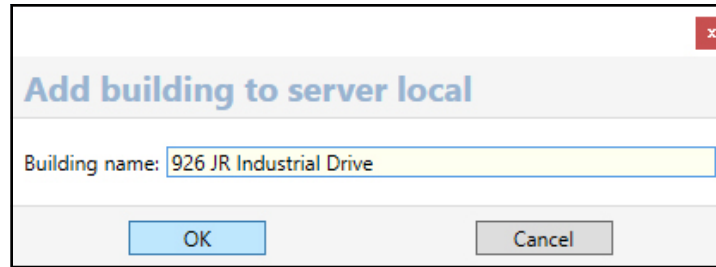

11. The building name will appear on the navigation pane in SMP Server Admin.

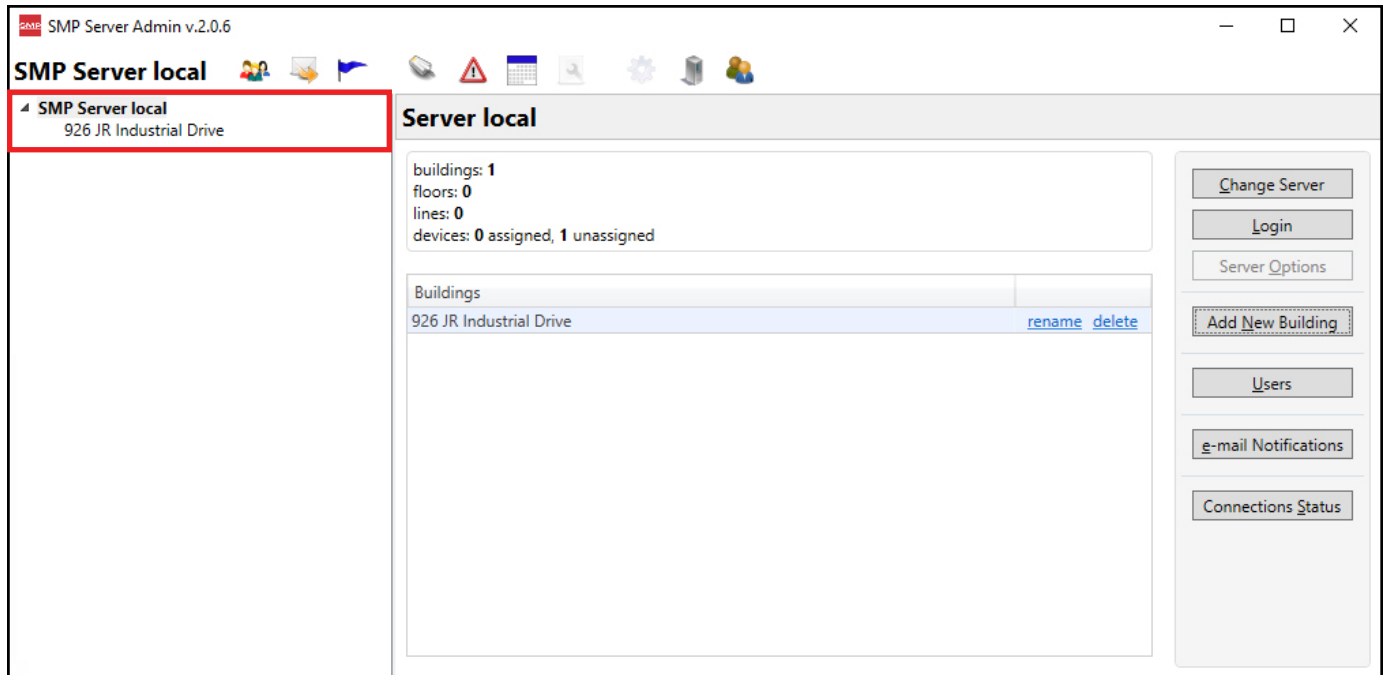

12. Click on the building name in the navigation pane, and then click the Add New Floor button.

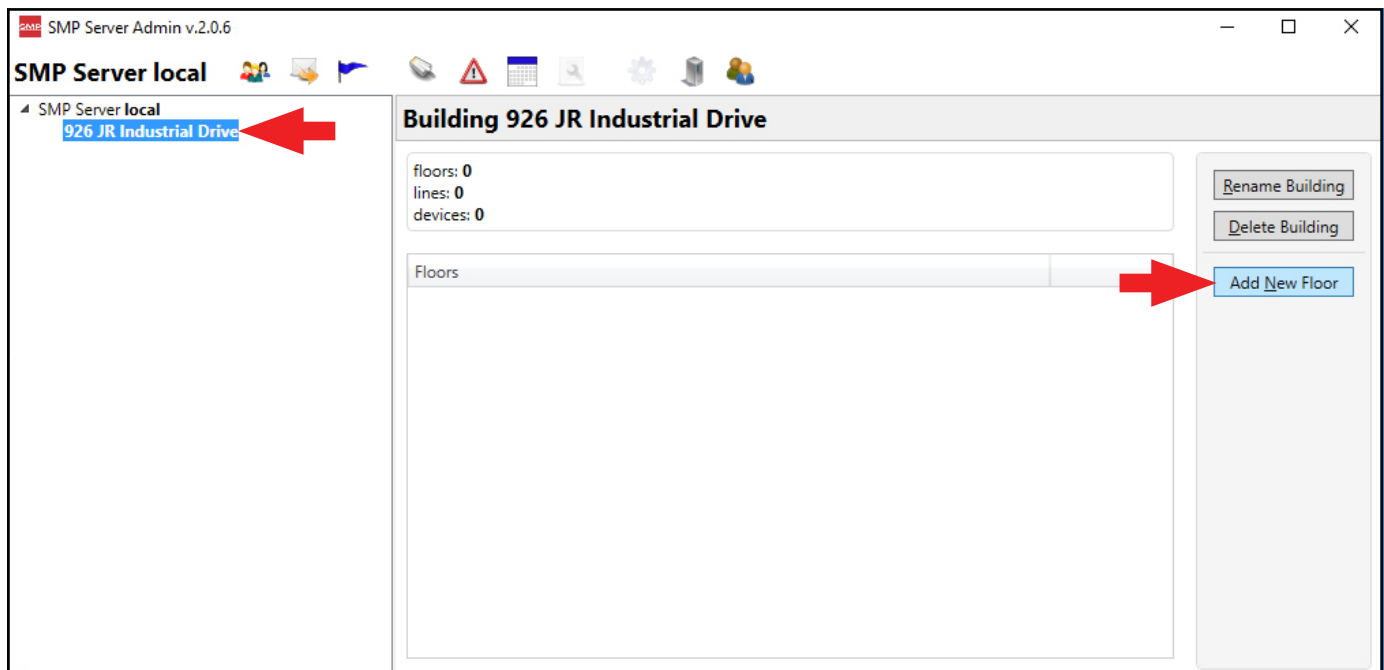

SCS - 926 JR Industrial Drive, Sanford, NC 27332
East: (919) 718-0000 | West: (909) 627-9634 • Website: StaticControl.com

13. Enter a floor name, and then click the OK button.

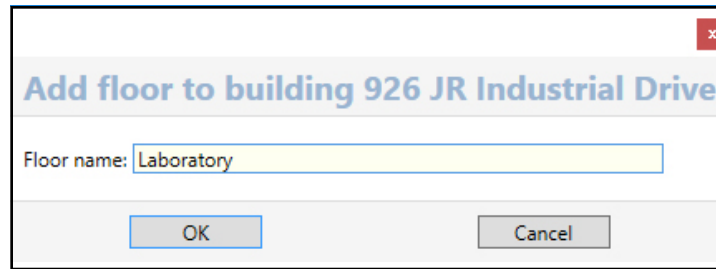

14. The floor name will appear on the navigation pane in SMP Server Admin.

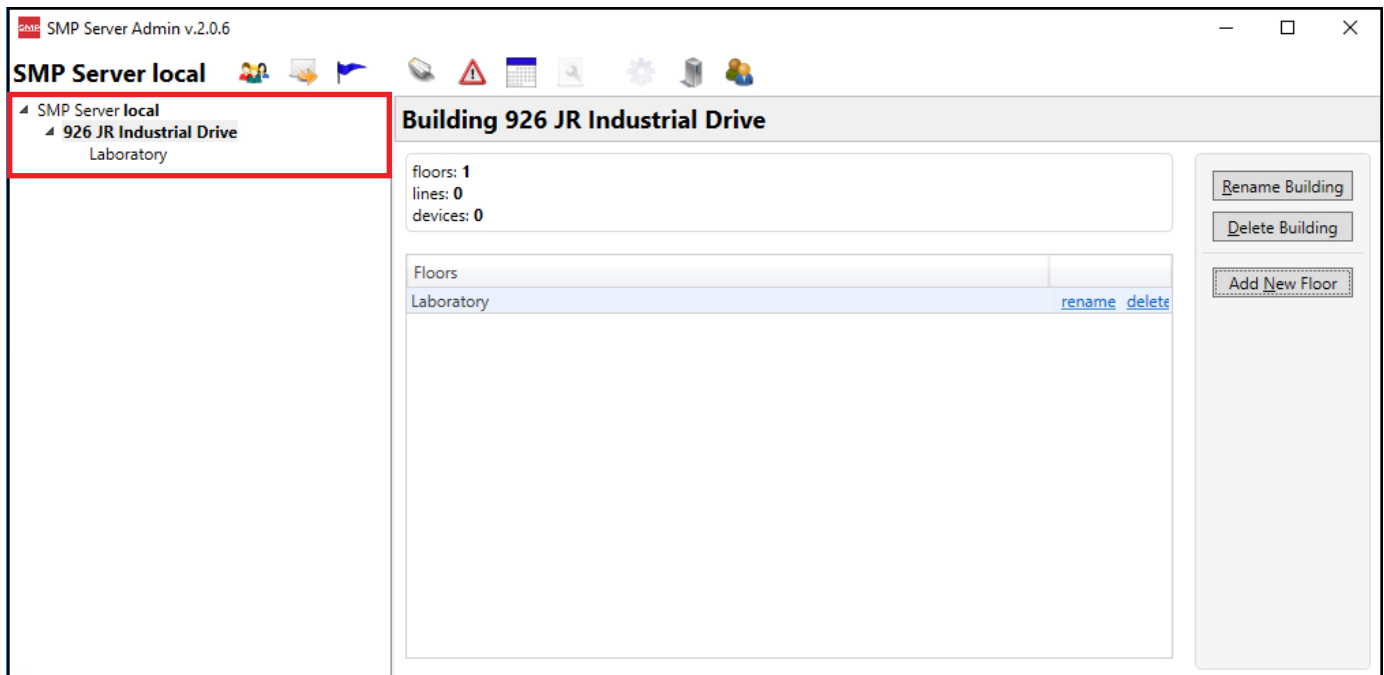

15. Click on the floor name in the navigation pane, and then click the Add New Line button.

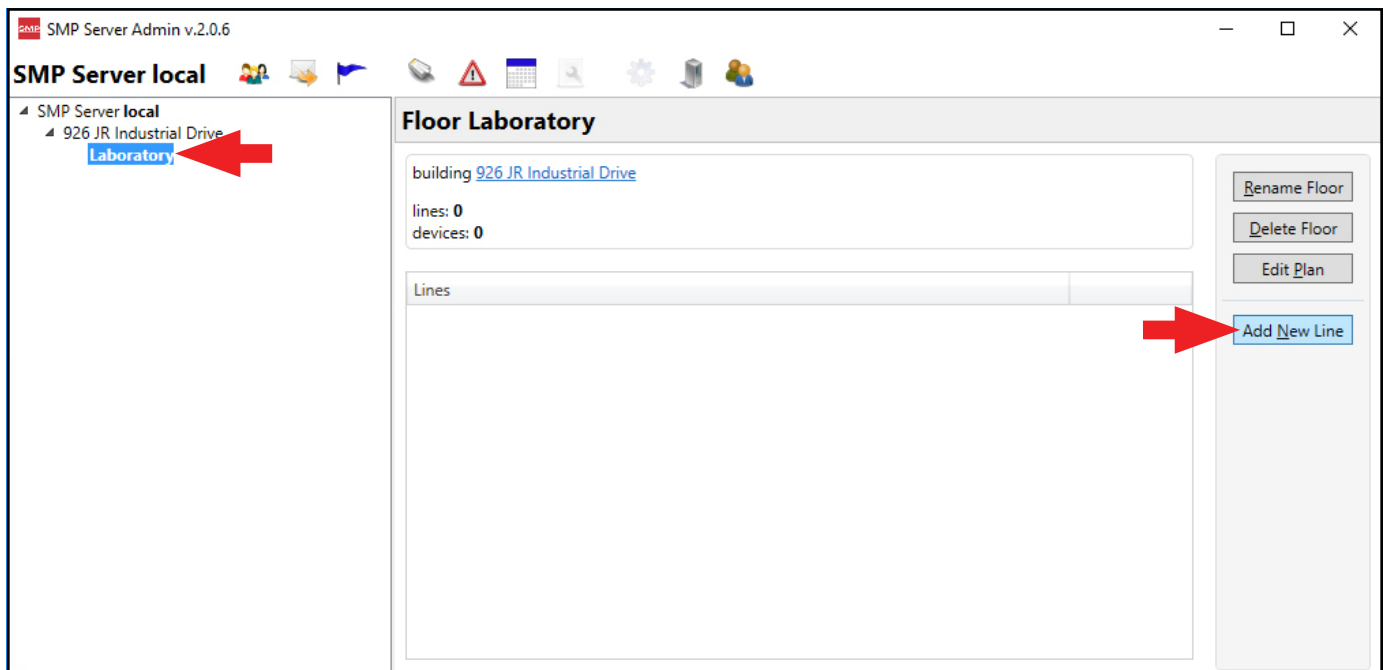

16. Enter a line name, and then click the OK button.

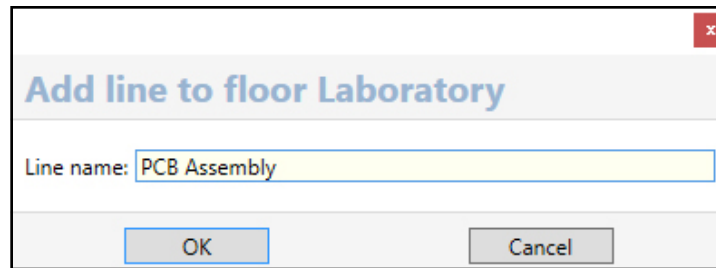

17. The line name will appear on the navigation pane in SMP Server Admin.

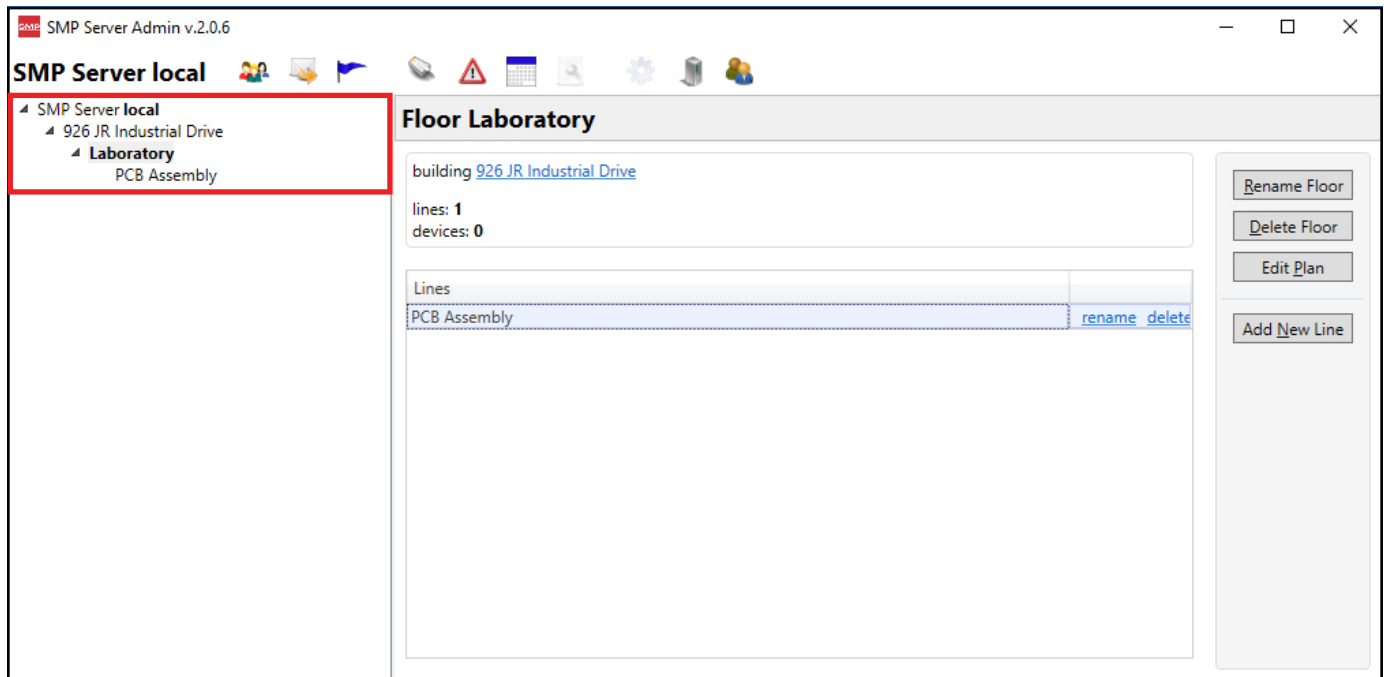

18. Click on the line name in the navigation pane, and then click the Attachable Devices arrow located at the bottom of the window.

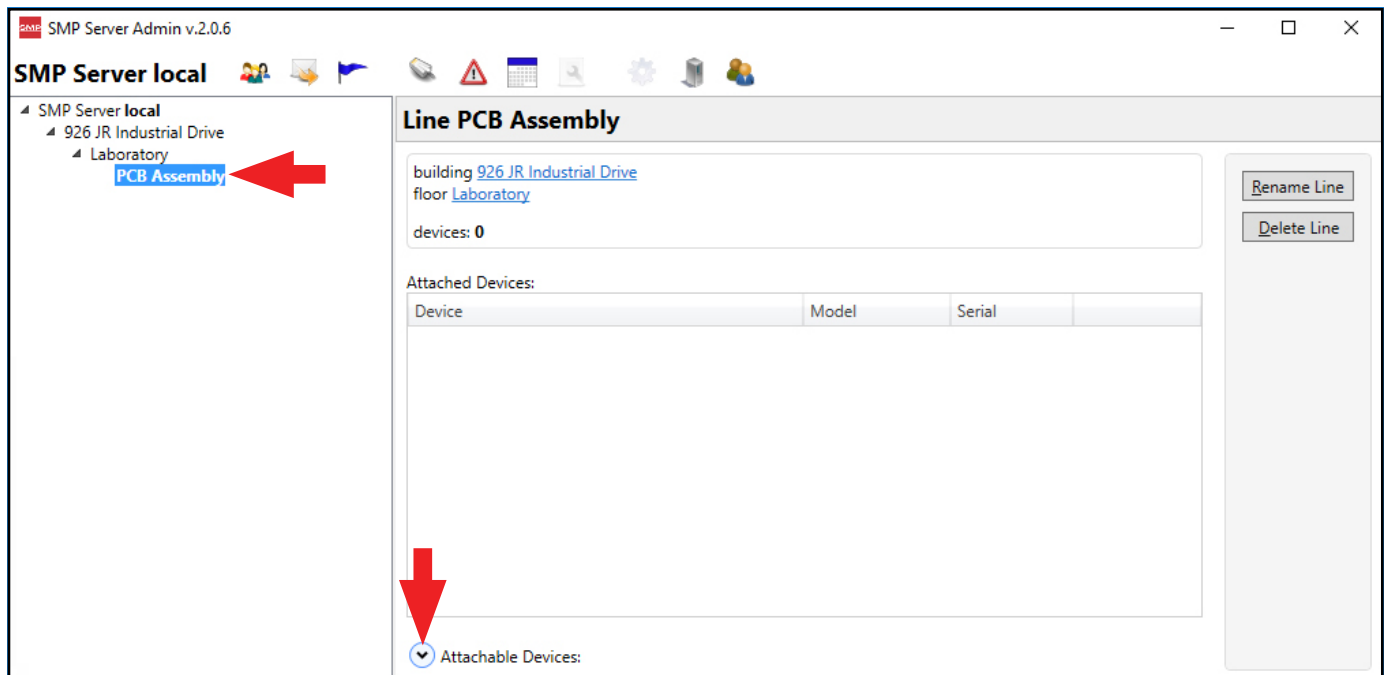

19. The serial number for the EM Aware Monitor will appear. Click attach.

SMP Server Admin v.2.0.6

SMP Server local

- SMP Server local
 - 926 JR Industrial Drive
 - Laboratory
 - PCB Assembly**

Line PCB Assembly

building [926 JR Industrial Drive](#)
floor [Laboratory](#)

devices: 0

Attached Devices:

Device	Model	Serial	
--------	-------	--------	--

Attachable Devices:

Name	Model	Serial	
[E4100400AAAA]	EM Aware	E4100400AAAA	attach

[Rename Line](#)
[Delete Line](#)

20. The EM Aware Monitor will attach to the selected line.

SMP Server Admin v.2.0.6

SMP Server local

- SMP Server local
 - 926 JR Industrial Drive
 - Laboratory
 - PCB Assembly**

Line PCB Assembly

building [926 JR Industrial Drive](#)
floor [Laboratory](#)

devices: 1

Attached Devices:

Device	Model	Serial	
[E4100400AAAA]	EM Aware	E4100400AAAA	rename detach

Attachable Devices:

Name	Model	Serial	
------	-------	--------	--

[Rename Line](#)
[Delete Line](#)

21. Open SCS SMP Client.

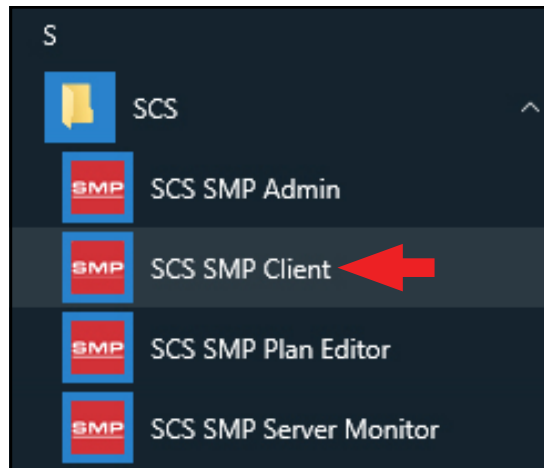

22. Verify that the EM Aware Monitor was added to the appropriate building, floor and line.

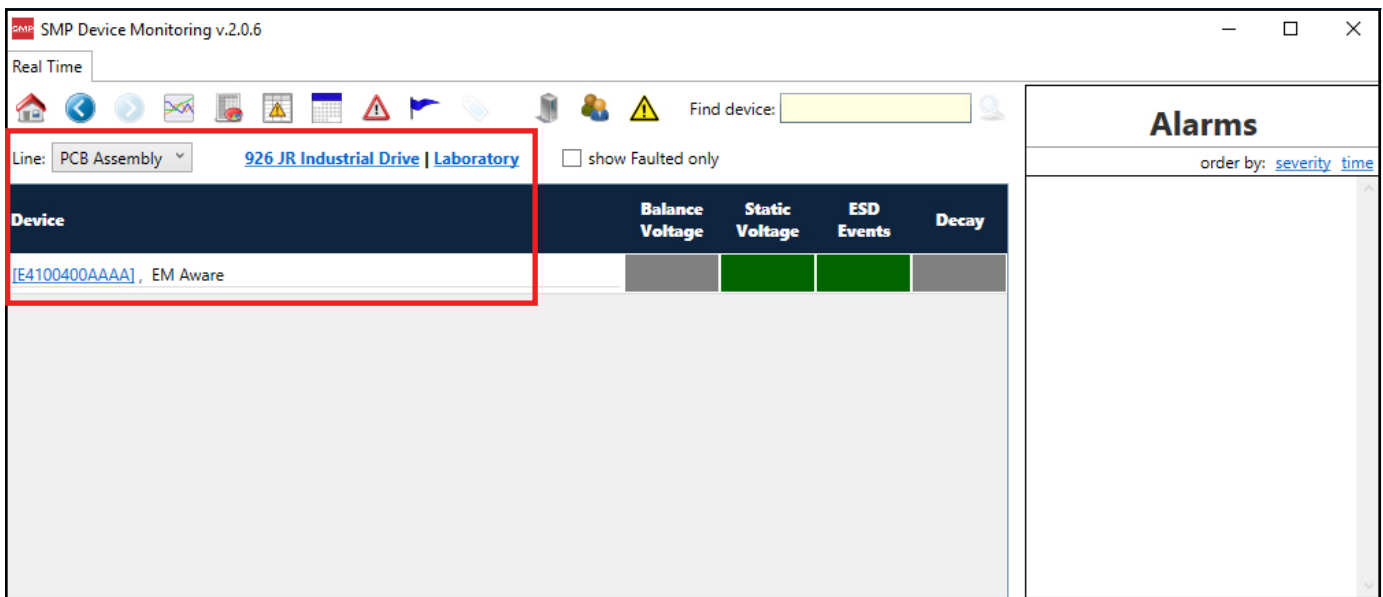

Operation

WARNING: Never apply or discharge voltage directly to the EM Aware Monitor's metal remote antenna as this may cause significant damage to the EM Aware Monitor.

Controlling the EM Aware Monitor

The EM Aware Monitor is controlled using a 5-position joystick located to the right of its display. The joystick can be toggled left, right, up, and down and pushed inward.

The EM Aware Monitor will default to the ESD Event display upon completion of its boot-up sequence. Toggle the joystick down to advance the display to the next channel, and toggle the joystick up to return to the previous channel. See Figure 9.

Push down and hold the joystick for 3 seconds to enter the displayed settings.

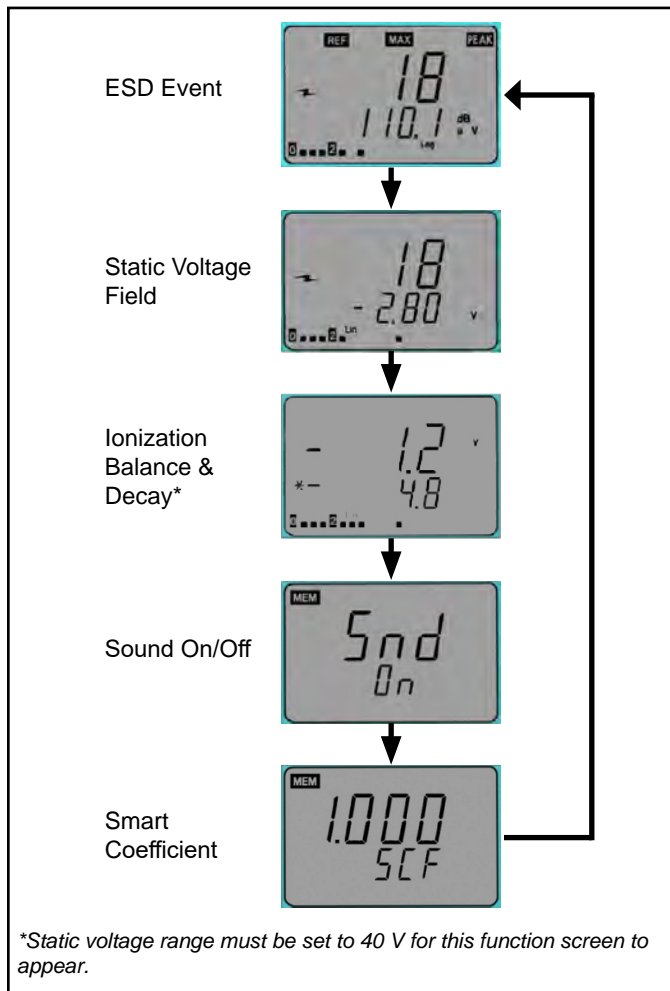

Figure 9. Cycling through the modes on the display

ESD Event Channel



Figure 10. ESD Event channel

REF: Indicator appears during ESD event threshold setup.

ESD Event Counting Mode: Denotes that ESD event counting is active

ESD Level Bar Graph: Displays the current ESD level.

ESD Threshold Marker: Marks the ESD event threshold on the ESD level bar graph.

MAX: Indicates the maximum magnitude of ESD event within the last second duration.

PEAK: Indicates that the noise filter is enabled. If "PEAK" is not displayed, the noise filter is disabled.

ESD Counter: Counts the number of events over the set threshold. The maximum number is 1999 and resets to 0 once this limit is exceeded.

ESD Event Peaks: Voltage level that is received by the antenna which is a result of an ESD event near the antenna. It is measured in dB μ V.

ESD Event Settings

1. Toggle the joystick until the ESD Event channel is displayed (see Figure 10).
2. To reset the ESD counter to zero, push down the joystick momentarily.
3. To change the ESD threshold, push down and hold the joystick until "ESD" is displayed. The "REF" indicator will appear on the top-left corner of the display to indicate that the ESD threshold value can be modified. Toggle the joystick left to decrease the threshold. Toggle the joystick right to increase the threshold. Hold the joystick in either direction to quickly increment the value.



Figure 11. Modifying the ESD event threshold

- When the noise filter is enabled, the EM Aware will detect mostly ESD events and ignore other signals such as EMI. If the noise filter is disabled, all signal types will be detected. To disable or enable the noise filter, enter the ESD threshold settings as described in the previous step, and then toggle the joystick up or down. "Cdr OFF" indicates that the filter is disabled, and "Cdr On" indicates that the filter is enabled.



Figure 12. Enabling the noise filter

- Push down the joystick momentarily to save all settings. "MEM" will appear temporarily in the top left corner while the settings are saved. The monitor will then re-boot after the save is completed.

NOTE: The monitor will revert back to its last saved settings if idled for 10 seconds while in the settings menu. The joystick must be pushed down in order to save all modifications to the settings.

Static Voltage Field Channel

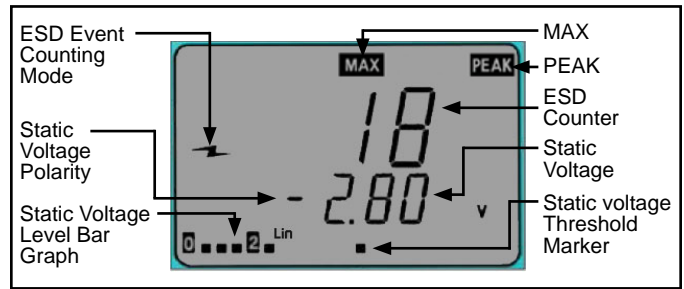

Figure 13. Static Voltage Field channel

ESD Event Counting Mode: Indicates that ESD event counting is active.

Static Voltage Polarity: Denotes the polarity of the static voltage peaks.

Static Voltage Level Bar Graph: Displays the current change in static voltage field magnitude regardless of polarity.

MAX: Indicates the maximum magnitude of static voltage within the last second duration.

PEAK: Appears when the measured static voltage exceeds the voltage range.

ESD Counter: Counts the number events over the set threshold. The maximum number is 1999 and resets to 0 once this limit is exceeded.

Static Voltage: The current value of the signal being measured by the antenna expressed in volts.

Static Voltage Threshold Marker: Marks the static voltage threshold setting.

Principle of Operation of Static Voltage Monitor

The Static Voltage channel measures the change of electrostatic field. Any change in electrostatic field induces voltage on the antenna via capacitive coupling. An electrostatic field that is stationary does not induce voltage on the antenna, so the EM Aware will show a decreasing value.

Indication of Static Voltage

The Static Voltage Level Bar Graph in the bottom left corner of the display indicates absolute magnitude of static voltage regardless of polarity. An audible alarm will sound when voltage of any polarity exceeds the preset alarm level.

Static Voltage Settings

1. Toggle the joystick until the Static Voltage channel is displayed (Figure 13).
2. To reset the ESD counter to zero, push down the joystick momentarily.
3. To change the voltage range and thresholds, push down and hold the joystick until "REF" is displayed on the top-left corner. "REF" indicates that the settings can be modified.
4. Toggle the joystick up or down to scroll through the voltage range options (12.5, 100, 250, 500, 1000 volts). Select the 12.5 volt range to enable the ionization balance function if desired.
5. Toggle the joystick left to decrease the threshold. Toggle the joystick right to increase the threshold. Hold the joystick in either direction to quickly increment the value.
6. Push down the joystick momentarily to save all settings. "MEM" will appear temporarily in the top left corner while the settings are saved. The monitor will then re-boot after the save is completed.

NOTE: The monitor will revert back to its last saved settings if idled for 10 seconds while in the settings menu. The joystick must be pushed down in order to save all modifications to the settings.

Ionization Balance and Decay Channel

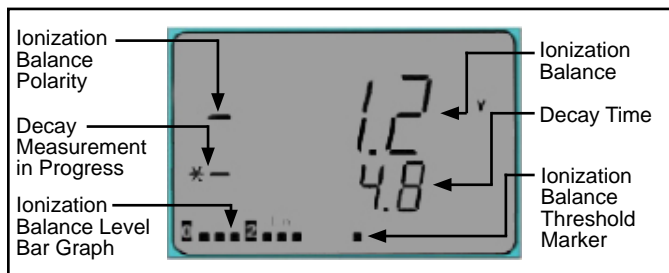

Figure 14. Balance and Decay Mode channel

Ionization Balance Polarity: Indicates the polarity of the ionizer's balance (offset voltage).

Decay Measurement in Progress: Appears when the decay time is being measured.

Ionization Balance Level Bar Graph: Indicates the balance (offset voltage) levels.

Ionization Balance: Displays the ionizer's balance (offset voltage).

Decay Time: Displays the amount of seconds to decay a static charge. "1--.--" will display if the decay time exceeds 16 seconds.

Ionization Balance Threshold Marker: Marks the balance (offset voltage) threshold setting.

NOTE: The EM Aware Monitor is compatible with steady-state DC critical environment ionizers only. The ionizer must have a balance (offset voltage) of $\pm 40V$ or better.

Ionization Balance and Decay Settings

NOTE: These settings cannot be changed unless the static voltage range is set to 40 volts. See "Static Voltage Settings" on page 15.

1. Toggle the joystick until the Ionization Balance and Decay channel is displayed (Figure 14).
2. Push down the joystick momentarily to manually measure the ionizer's balance (offset voltage) and decay time. The *- symbols will appear while the measurements are being taken. The balance (upper row) and decay time (lower row) will update at the end of the tests. Balance and decay time are automatically measured every three minutes. Static voltage monitoring becomes idle when balance and decay tests are performed. ESD event monitoring operates normally.
3. To change the voltage range and thresholds, push down and hold the joystick until "REF" is displayed on the top-left corner. "REF" indicates that the settings can be modified. The value in the top row indicates the current balance threshold, and the value in the bottom row indicates the decay time threshold.
4. Toggle the joystick down to decrease the decay time threshold. Toggle the joystick up to increase the decay time threshold. Hold the joystick in either direction to quickly increment the value.

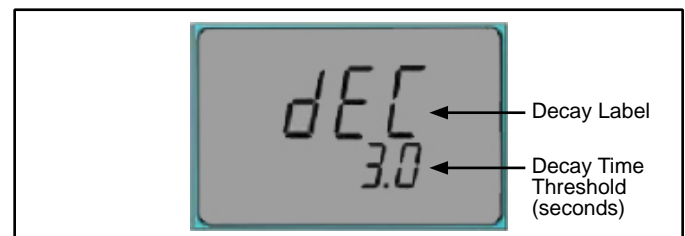

Figure 15. Decay time threshold settings

5. Toggle the joystick left to decrease the balance threshold. Toggle the joystick right to increase the balance threshold. Hold the joystick in either direction to quickly increment the value.



Figure 16. Ionization balance screen

6. Push down the joystick momentarily to save all settings. "MEM" will appear temporarily in the top left corner while the settings are saved. The monitor will then re-boot after the save is completed.

NOTE: The monitor will revert back to its last saved settings if idled for 10 seconds while in the settings menu. The joystick must be pushed down in order to save all modifications to the settings.

Audible Alarm Settings

1. Toggle the joystick until the Sound channel is displayed.



Figure 17. Sound On/Off screen

2. To change the audible alarm setting, push down and hold the joystick until the setting below "Snd" blinks.



Figure 18. Sound On/Off change screen

3. Toggle the joystick left or right to disable or enable the audible alarm.
4. Push down the joystick momentarily to save all settings. "MEM" will appear temporarily in the top left corner while the settings are saved. The monitor will then re-boot after the save is completed.

Smart Coefficient (SCF)

The Smart Coefficient (SCF) feature works in conjunction with the static voltage field channel. This feature is useful when an approximate voltage is desired, especially when the distance is not exact. For example, a known 1000 V static voltage source should show approximately 1000 V on the EM Aware Monitor when its antenna is 5 inches away from the static voltage source. This 1000 V approximation will change as the antenna is located further away from the static voltage source. It may show a value close to 600 V instead.

The Smart Coefficient function allows a correction factor to compensate for the variable distance. To bring the approximated voltage value back to 1000 V, the SCF value will have to be set to 1.66. Alternatively, if the antenna is moved closer, the monitor may show 1400 V. In this case, an SCF value of 0.71 will bring the reading back to 1000 V.

NOTE: All numbers referenced in the previous paragraph are for illustration purposes only. They should not be referenced for accuracy.

The Smart Coefficient has a default setting of 1.000, and it can be adjusted from 0.001 to 1.999. When adjusting the Smart Coefficient, it is important to have a known static voltage source as a reference for setting the SCF value. This voltage source may be a Pulse Generator, a Charged Plate Monitor (1 kV typically), or a Function Generator.

Smart Coefficient (SCF) Settings

1. Toggle the joystick until the Smart Coefficient channel is displayed.



Figure 19. Smart Coefficient channel

2. To change the Smart Coefficient value, push down and hold the joystick until the value blinks and "REF" is displayed on the top-left corner. "REF" indicates that the settings can be modified.

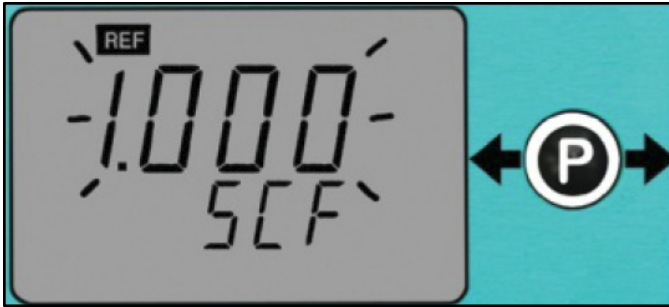

Figure 20. Setting the Smart Coefficient value

3. Toggle the joystick left to decrease the value. Toggle the joystick right to increase the value. Hold the joystick in either direction to quickly increment the value.
4. Push down the joystick momentarily to save all settings. "MEM" will appear temporarily in the top left corner while the settings are saved. The monitor will then re-boot after the save is completed.

NOTE: The monitor will automatically save the value on the display if idled for 10 seconds while in the settings menu.

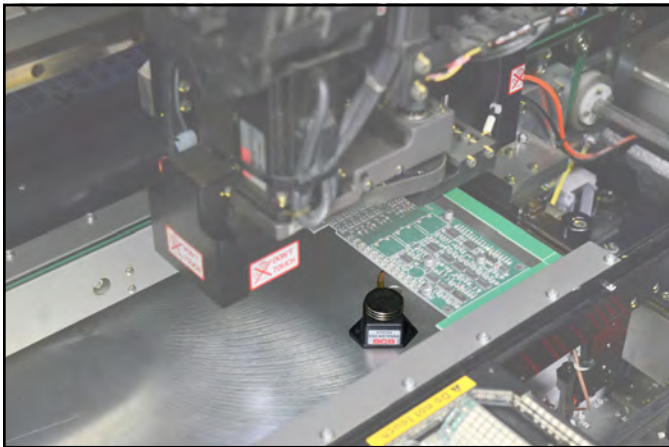

Figure 21. Using the EM Aware Monitor with standard antenna inside of a pick-and-place machine

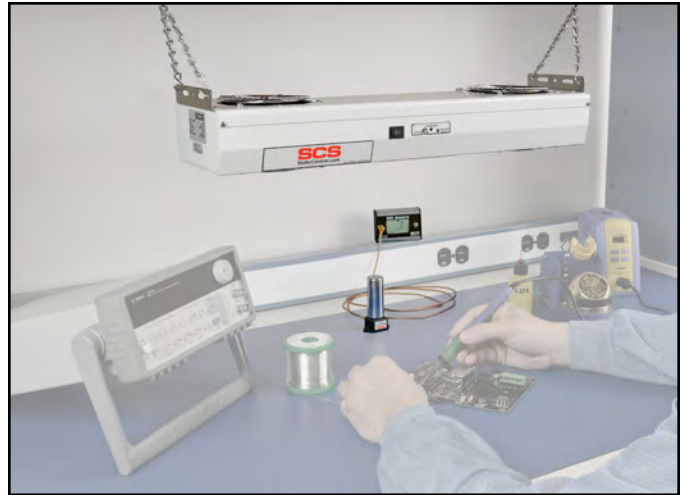

Figure 22. Using the EM Aware Monitor with ionizer antenna on a workbench with the SCS [770112](#) Ion Pro™ Overhead Ionizer



Figure 23. Using the EM Aware Monitor with ionizer antenna on an SMT conveyor with the SCS [963E](#) Benchtop Air Ionizer

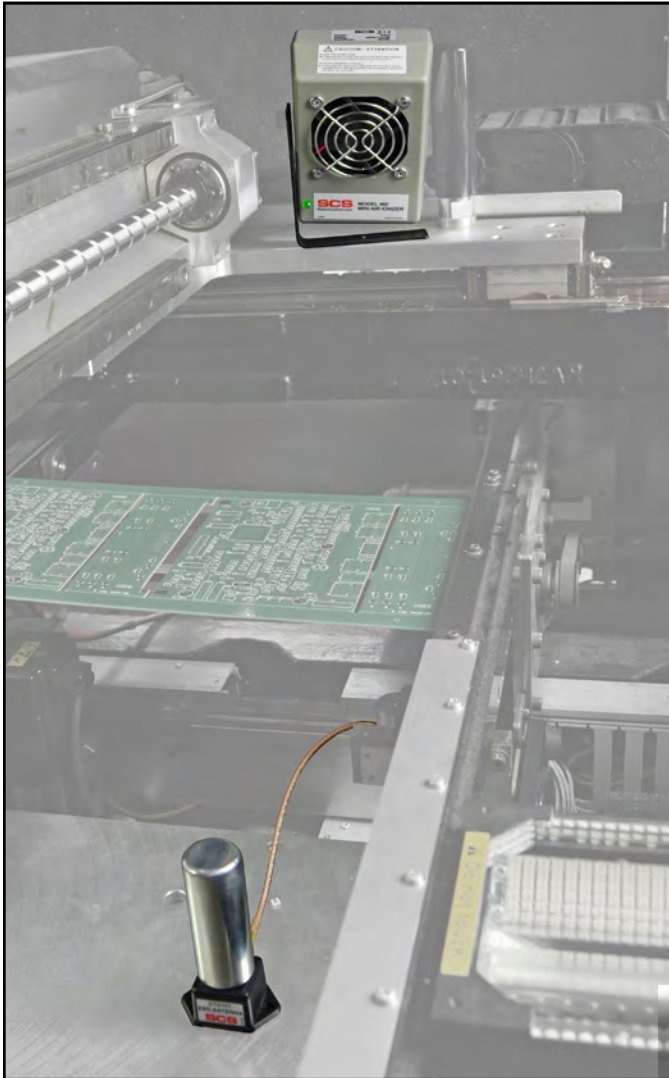

Figure 24. Using the EM Aware Monitor with ionizer antenna inside of a pick-and-place machine with the SCS [960 Mini Air Ionizer](#)

EM Aware Calculator Software

Use the EM Aware Calculator to estimate ESD event voltages. Simply enter the dB μ V measurement from the EM Aware Monitor and the distance from the event source to the remote antenna. The EM Aware Calculator will provide an approximate voltage for the ESD event based on CDM, HBM and MM models.

1. Use the link below to download the EM Aware Calculator Software.
StaticControl.com/Downloads/EMAwareCalculator.zip
2. Extract the contents of the zip folder, and run "setup.exe". Follow the on-screen prompts to install the software.
3. Run the EM Aware Calculator to estimate ESD event voltages based off dB μ V measurements from the EM Aware Monitor and distance settings.

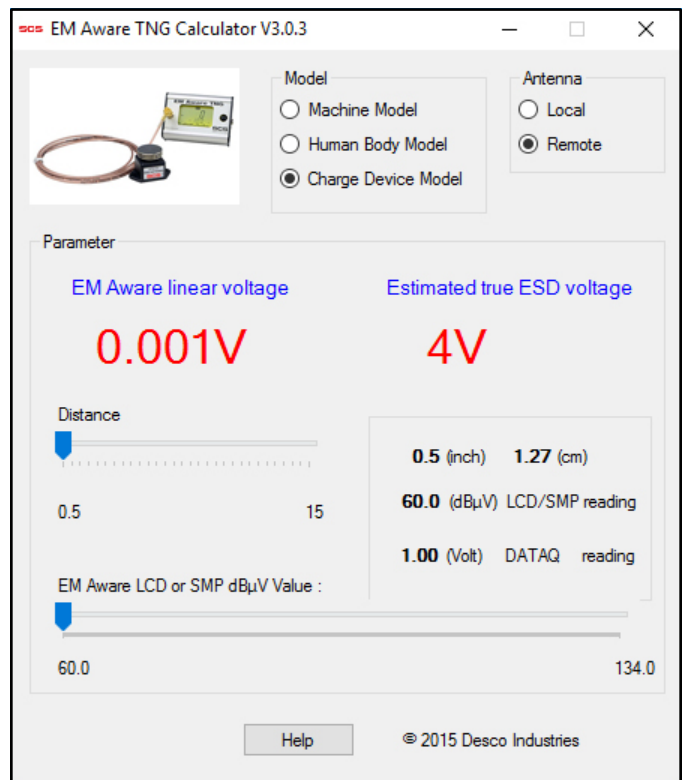

Figure 25. EM Aware Calculator Software

Maintenance

Cleaning

Disconnect the power adapter from the device. Clean the EM Aware Monitor and its antenna using a dry brush or vacuum cleaner should dust accumulate on the items. Clean its contacts using a contact cleaner or brush, and tighten all connections. Do not reconnect the power adapter until cleaning is finished.

Repairs and Servicing

There are no user-serviceable parts. Do not attempt to repair the EM Aware Monitor yourself. Contact an SCS sales representative or authorized distributor to request inspection and repair.

Calibration

Frequency of verification is based on the critical nature of the ESD susceptible items handled. SCS recommends annual calibration of the EM Aware Monitor. Contact an SCS sales representative or authorized distributor to request product calibration if necessary.

Specifications

Power

Power Adapter	Output: 7.5 VDC @ 1.5 A
100-240 VAC	Output Plug Polarization: Center Positive
50-60 Hz	Output Plug: 5.5 mm O.D. x 2.1 mm I.D. x 9.5 mm L

ESD Event Monitor

Measurement	Magnitude ESD Event
ESD Event Threshold	Default setting: 80 dB μ V
Raw Input Signal	60 dB μ V (~1mV) to 134 dB μ V (~5.0 V)
Filtering Function	ESD

Static Voltage Monitor

Measurement	Static Voltage - Change of electrostatic field
Static Voltage Setting Range	12.5 V, 100 V, 250 V, 500 V, 1000 V, smart coefficient adjust
Output	Ethernet

Ionizer Voltage and Decay Monitor

Compatible Ionizer	Steady-State DC
Max. Decay Time Reading	16 seconds** max, typical
Max. Decay Test Voltage	± 5 V

Connectivity

Input	SMA Connector for Remote antenna
Outputs	RJ45 connector for Ethernet output; 2-position terminal block for relay output

General

Alarm	Buzzer
Display	LCD
Dimensions (antenna not included)	3.17" W x 2.25" H x 1.26" D (81 mm W x 57 mm H x 32 mm D)
Weight	183 g

***The readings of ionization voltage and decay under identical conditions may not always correlate with a charged plate monitor. The EM Aware Monitor is not intended to replace regular testing of ionizers by a charged plate monitor.*

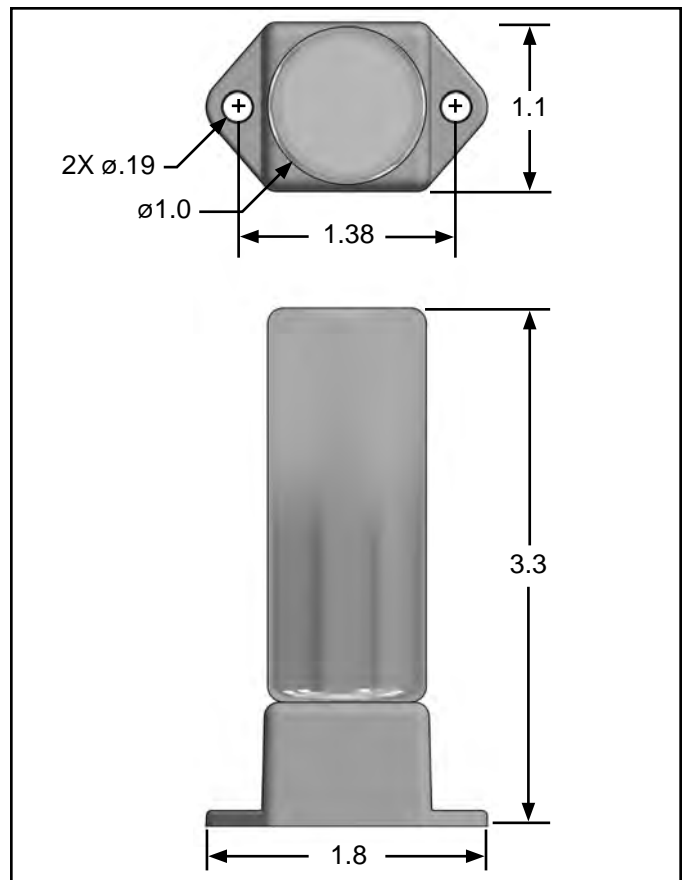

Figure 26. Ionizer antenna dimensions (inches)

Limited Warranty, Warranty Exclusions, Limit of Liability and RMA Request Instructions

See the SCS Warranty -

StaticControl.com/Limited-Warranty.aspx